

B0520WS/B0530WS/B0540WS

SOD-323

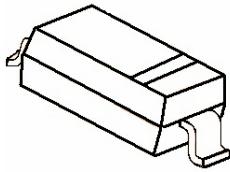

Marking: B0520WS: SD
B0530WS: SE
B0540WS: SF

SOD-323 贴片塑封肖特基二极管

SOD-323 Plastic-Encapsulate Schottky Barrier Diode

特征 Features

- 大电流承受能力。High Current Capability
- 正向压降低。Low Forward Voltage Drop

机械数据 Mechanical Data

- 封装: SOD-323 封装 SOD-323 Small Outline Plastic Package
- 极性: 色环端为负极 Polarity: Color band denotes cathode end
- 环氧树脂 UL 易燃等级 Epoxy UL: 94V-0
- 安装位置: 任意 Mounting Position: Any

极限值和温度特性(TA = 25°C 除非另有规定)

Maximum Ratings & Thermal Characteristics (Ratings at 25°C ambient temperature unless otherwise specified.)

参数 Parameters	符号 Symbol	B0520WS	B0530WS	B0540WS	单位 Unit
最大可重复峰值反向电压 Maximum repetitive peak reverse voltage	VRRM	20	30	40	V
最大均方根电压 Maximum RMS voltage	VRMS	14	21	28	V
最大直流阻断电压 Maximum DC blocking voltage	VDC	20	30	40	V
最大正向平均整流电流 Maximum average forward rectified current	IFM	0.5			A
峰值正向浪涌电流 8.3ms 单一正弦半波 Peak forward surge current 8.3 ms single half sine-wave	IFSM	5.5			A
典型热阻 Typical thermal resistance	RθJA	500			°C/W
功率消耗 Power Dissipation	PD	200			mW
结温 Junction Temperature	Tj	125			°C
存储温度 Storage temperature range	TSTG	-50-+150			°C
电压率变化 Voltage rate of change	Dv/dt	1000			V/μs

电特性 (TA = 25°C 除非另有规定)

Electrical Characteristics (Ratings at 25°C ambient temperature unless otherwise specified).

参数 Parameters	符号 Symbol	测试条件 Test conditions	B0520WS	B0530WS	B0540WS	单位 Unit
最大正向电压 Maximum forward voltage	VF	IF = 0.1A	0.330	0.375	---	V
		IF = 0.5A	0.390	0.450	0.510	
		IF = 1.0A	---	---	0.620	
最大反向电压 Maximum reverse breakdown voltage	VR	IR=250uA	20	---	---	V
		IR=200uA	---	30	---	
		IR=20.0uA	---	---	40	
最大反向电流 Maximum reverse current	IR	VR=10V	75	---	---	uA
		VR=15V	---	80	---	
		VR=20V	250	---	10	
		VR=30V	---	500	---	
		VR=40V	---	---	20	
Capacitance between terminals	CT	VR = 0V, f = 1MHz	170			pF

B0520WS/B0530WS/B0540WS

特性曲线 Characteristic Curves

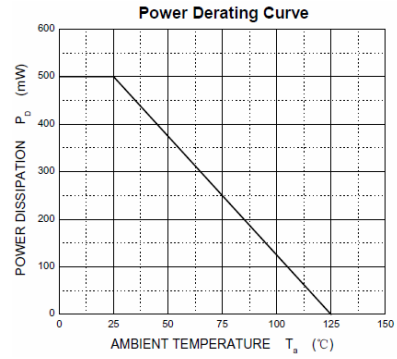
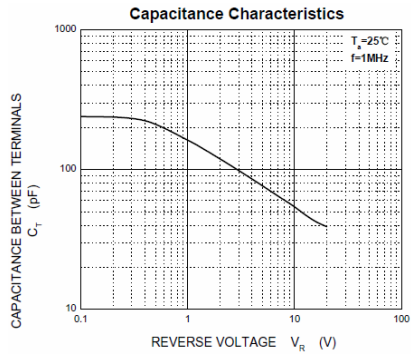
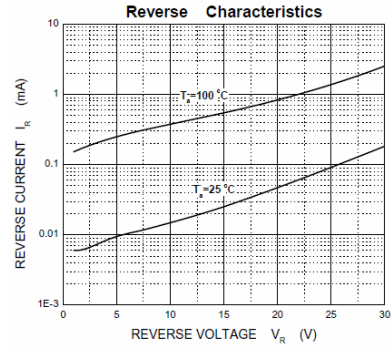
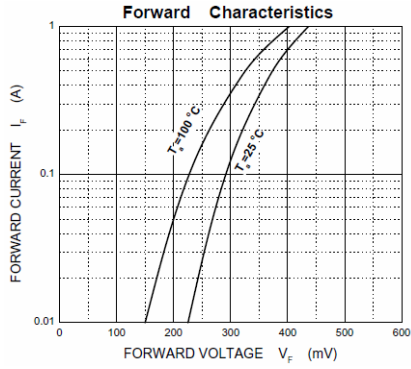

SOD-323 PACKAGE OUTLINE Plastic surface mounted package

SOD-323

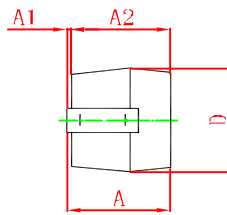
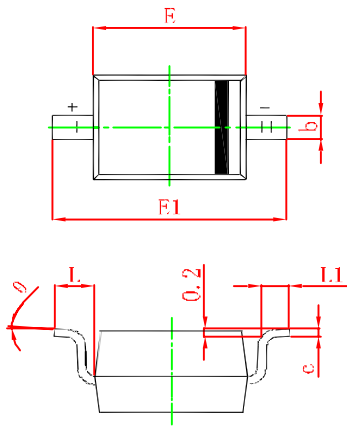

Symbol	Min.(mm)	Max.(mm)
A		1.000
A1	0.000	0.100
A2	0.800	0.900
b	0.250	0.350
c	0.080	0.150
D	1.200	1.400
E	1.600	1.800
E1	2.500	2.700
L	0.475REF	
L1	0.250	0.400
θ	0°	8°